

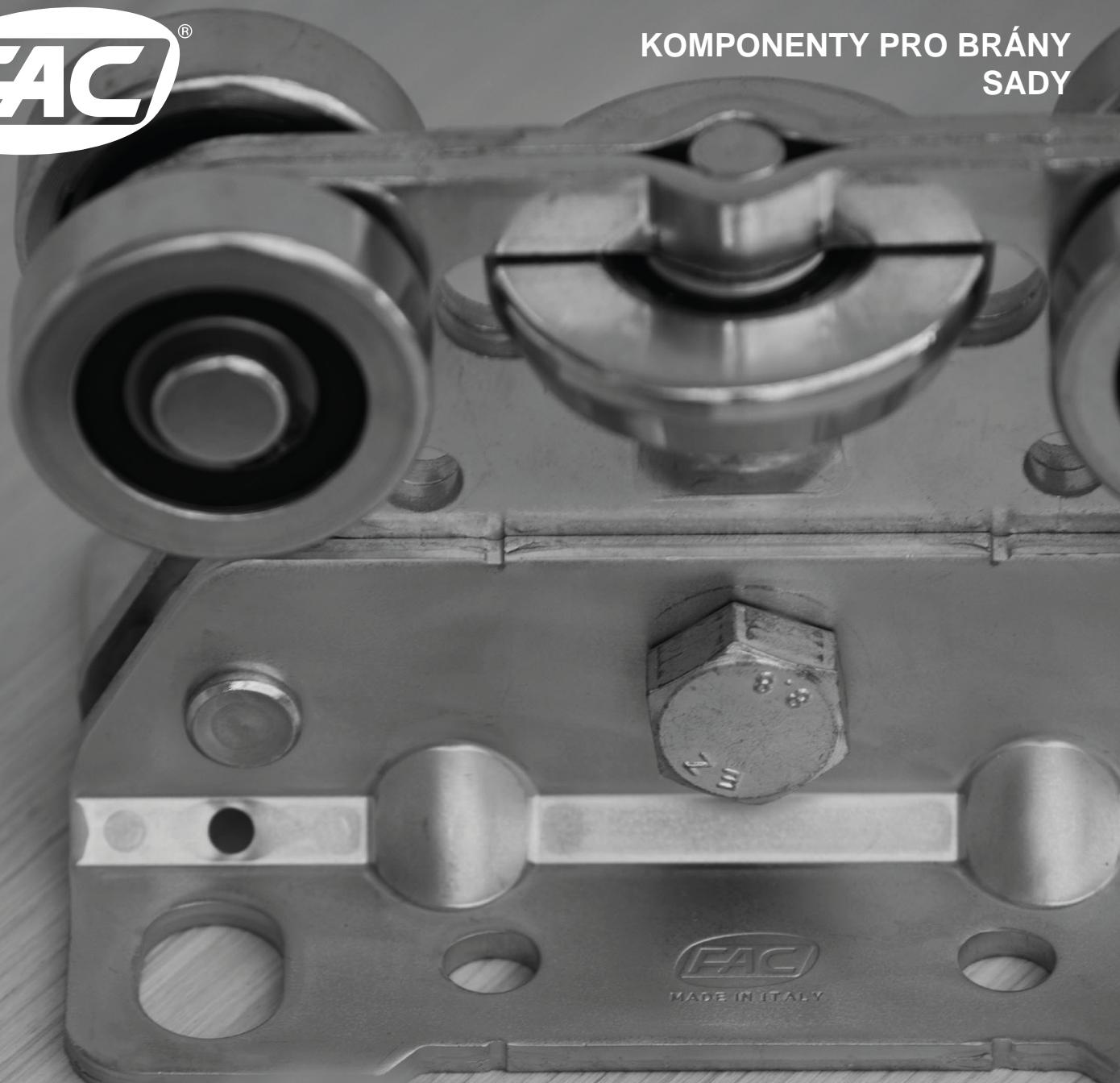

KOMPONENTY PRO BRÁNY  
SADY



« NOVÉ

**SAMONOSNÉ BRÁNY**



**KD1000.080**

## Sada pro samonosnou bránu, **ŘADA 800**

pro průjezd do 3,6 m, max. hmotnost brány 270 kg

artikly v sadě



2 x VD1100.044



1 x VD1203.044



1 x VD1303.044



1 x VL2201.050.N

### VODICÍ PROFILY

zinek

3m VD1403.044

6m VD1406.044

natural

3m VD1403.044.L

6m VD1406.044.L

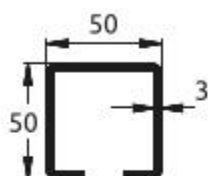

### VOZÍKY

VD1100.044

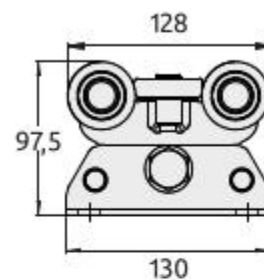
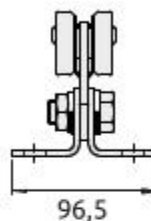

### SOUVISEJÍCÍ ARTIKLY



VA3206



VA4203

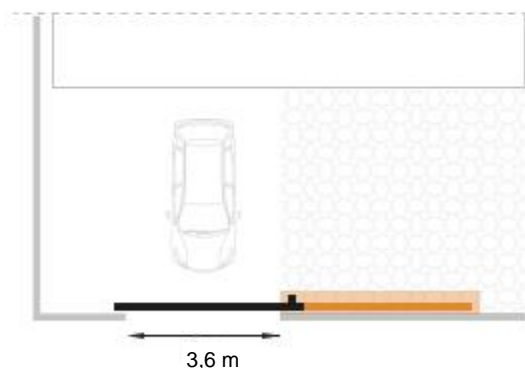

**NOVÉ ŘADY PRO SAMONOSNÉ BRÁNY**



**KD1000.090**

# Sada pro samonosnou bránu, **ŘADA 900**

pro průjezd do 4,5 m, max. hmotnost brány 420 kg

artikly v sadě



2 x VD1100.053



1 x VD1203.053



1 x VD1303.053



1 x VD1202.053

## VODICÍ PROFILY

zinek

3m VD1403.053

6m VD1406.053

natural

3m VD1403.053.L

6m VD1406.053.L

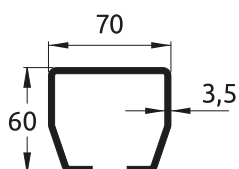

## VOZÍKY

VD1100.053

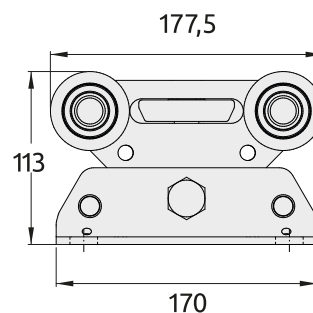
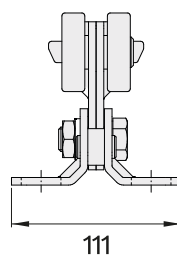

## SOUVISEJÍCÍ ARTIKLY



VA3206



VA4203

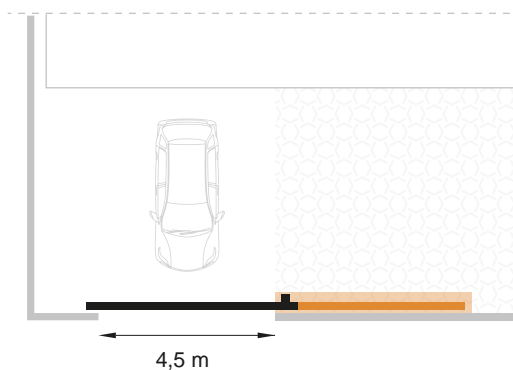

KOMPONENTY PRO BRÁNY - SADY





**KD1000.100**

## Sada pro samonosnou bránu, **ŘADA 1000**

pro průjezd do 6 m, max. hmotnost brány 600 kg

artikly v sadě



2 x VD1100.075



1 x VD1200.075



1 x VD1303.075



1 x VD1202.075

### VODICÍ PROFILY

zinek

3m VD1403.075

6m VD1406.075

natural

3m VD1403.075.L

6m VD1406.075.L

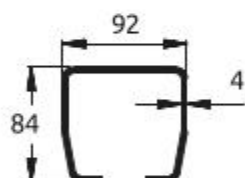

### VOZÍKY

VD1100.075

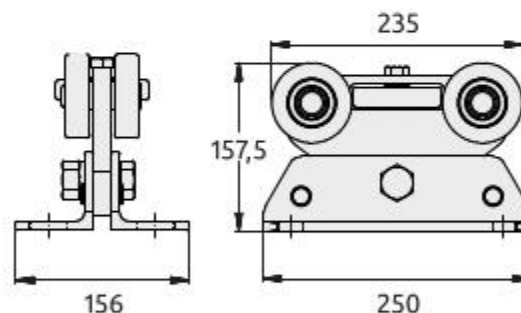

### SOUVISEJÍCÍ ARTIKLY



VA3206



VA4203

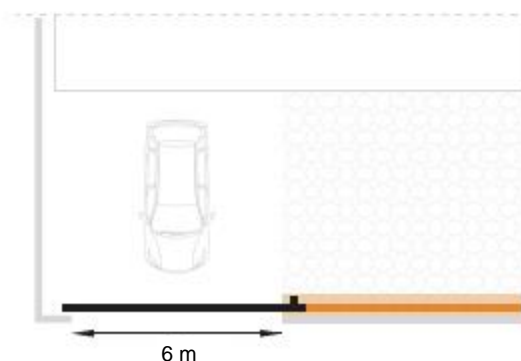

**NOVÉ ŘADY PRO SAMONOSNÉ BRÁNY**



67

KOMPONENTY PRO BRÁNY - SADY



ŘADA 2000

STANDARD

## Sada pro samonosnou bránu, ŘADA 2000



VD1100.100

pro průjezd do 9 m, max. hmotnost brány 850 kg

### VODICÍ PROFILY

zinek

3m VD1403.100

6m VD1406.100

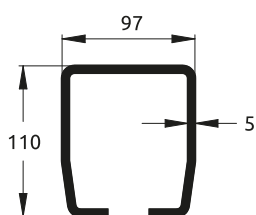

### VOZÍKY

VD1100.100

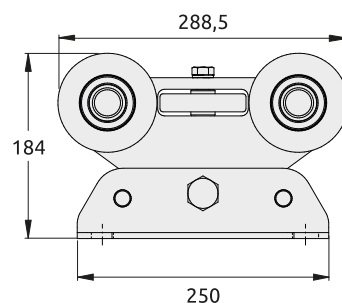
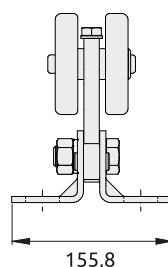

natural

3m VD1403.100.L

6m VD1406.100.L

ŘADA 2000H

## Sada pro samonosnou bránu, ŘADA 2000H



VD1110.100

pro průjezd do 16 m, max. hmotnost brány 1600 kg

### VODICÍ PROFILY

zinek

3m VD1403.100

6m VD1406.100

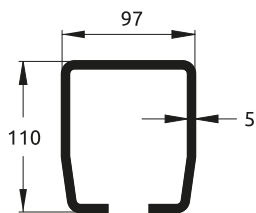

### VOZÍKY

VD1110.100

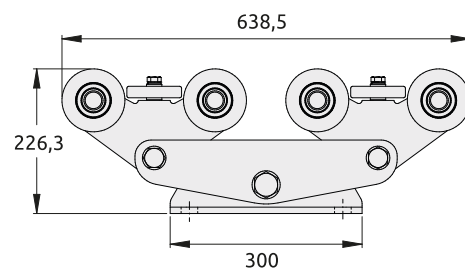
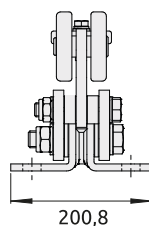

natural

3m VD1403.100.L

6m VD1406.100.L

NOVÉ ŘADY PRO SAMONOSNÉ BRÁNY



VD1100.250

NOVÉ

ŘADA 2500

## Sada pro samonosnou bránu, ŘADA 2500

Kompaktní řešení pro průjezd do 10 m, max. hmotnost brány 1000 kg

### VODICÍ PROFILY zinek

3m VD1403.250  
6m VD1406.250

natural

3m VD1403.250.L  
6m VD1406.250.L

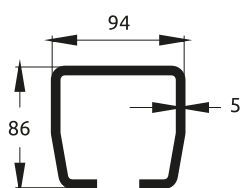

### VOZÍKY

VD1100.250

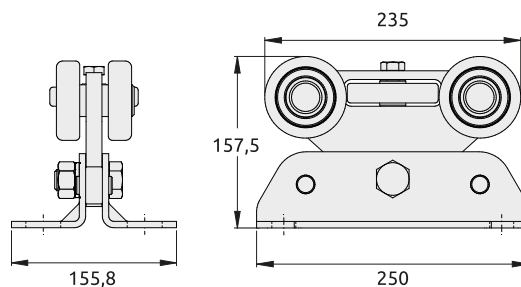

## SOUVISEJÍCÍ ARTIKLY

Dělené horní vedení brány  
regulovatelné  
se 4 vodícími kladkami a fixací na zed'



VA3204

Horní dojezdová kapsa



VD1301

Podpěra dojezdové  
kapsy



VD1600

Kotevní závitová  
tyč



VD1701

Dojezdové kapsy a přední dorazy



VD1300



VD1303

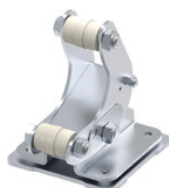

VD2350



VD1204



VD1201



VD1202

KOMPONENTY PRO BRÁNY - SADY



## ŘADA 3000

# Sada pro samonosnou bránu, ŘADA 3000

pro průjezd do 14 m, max. hmotnost brány 1500 kg



VD1101.300

### VODICÍ PROFILY zinek

3m VD1403.300  
6m VD1406.300

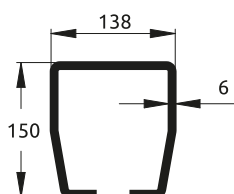

### VOZÍKY

VD1101.300

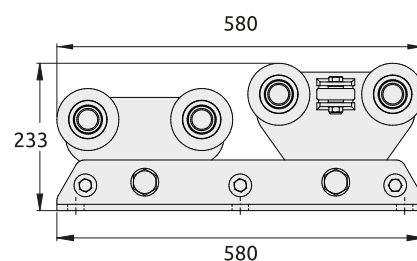
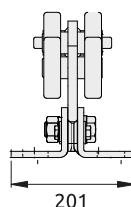

### natural

3m VD1403.300.L  
6m VD1406.300.L

## ŘADA 3500

NOVÉ

# Sada pro samonosnou bránu, ŘADA 3500

pro průjezd do 16 m, max. hmotnost brány 2000 kg



VD1101.350

### VODICÍ PROFILY

3m VD1403.350.L\*  
6m VD1406.350.L\*

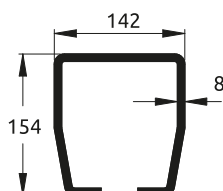

### VOZÍKY

VD1101.350

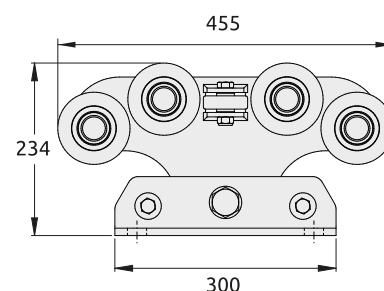
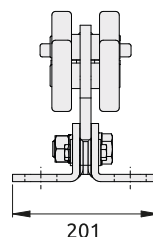

\*na vyžádání je k dispozici zároveň  
pozinkovaný profil

NOVÉ ŘADY PRO SAMONOSNÉ BRÁNY





VD1111

NOVÉ

ŘADA 4000

# Sada pro samonosnou bránu, ŘADA 4000

pro průjezd do 20 m, max. hmotnost brány 3500 kg

## VODICÍ PROFIL natural

4,5m VD1445.400.L

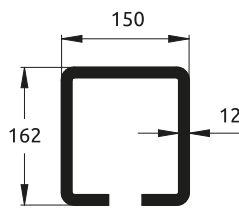

## VOZÍKY

VD1111

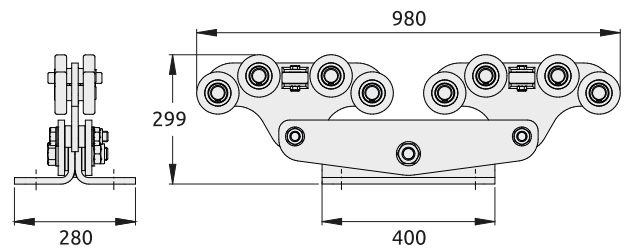

## SOUVISEJÍCÍ ARTIKLY

Dělené horní vedení brány  
regulovatelné  
se 4 vodicími kladkami a fixací na  
zeď



VA3204

Horní dojezdová kapsa

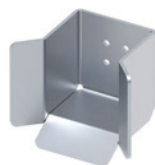

VD1301

Podpěra dojezdové  
kapsy



VD1600

Kotevní závitová  
tyč



VD1701

Dojezdové kapsy a přední dorazy

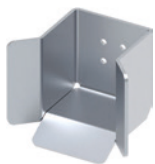

VD1300



VD1200



VD1303

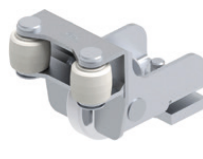

VD1201



VD1202

## APLIKACE

	PRO PRŮJEZD DO	MAX. HMOTNOST BRÁNY
ŘADA 800	3,6 m	270 kg
ŘADA 900	4,5 m	420 kg
ŘADA 1000	6 m	600 kg
ŘADA 2000	9 m	850 kg
ŘADA 2500 <b>NOVÉ</b>	10 m	1000 kg
ŘADA 3000	14 m	1500 kg
ŘADA 2000H	16 m	1600 kg
ŘADA 3500 <b>NOVÉ</b>	16 m	2000 kg
ŘADA 4000 <b>NOVÉ</b>	20 m	3500 kg

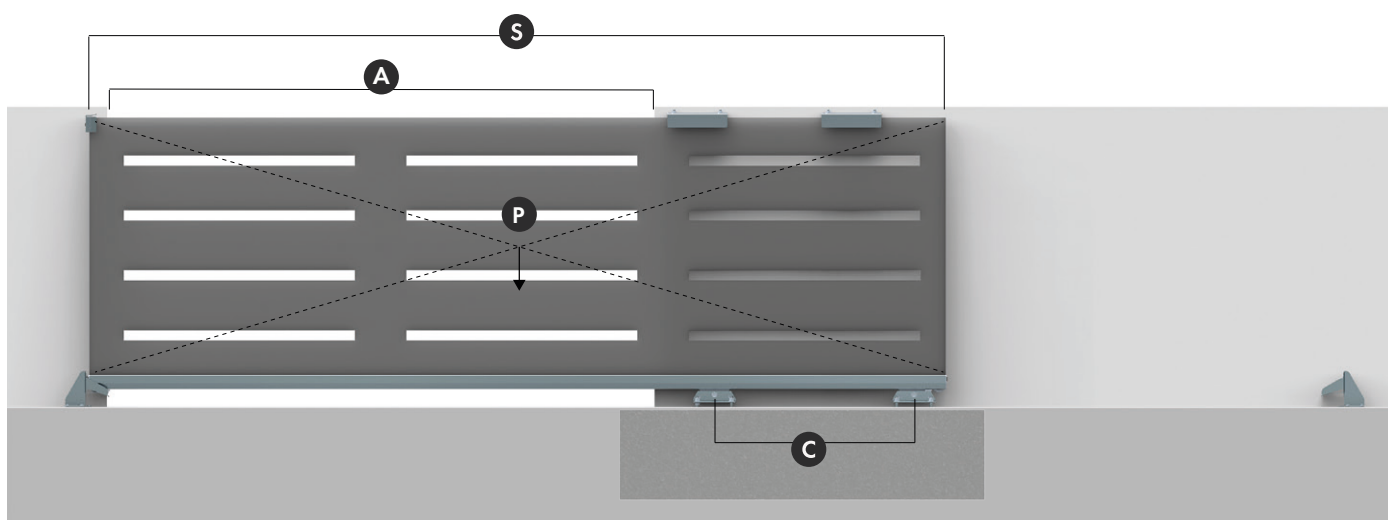
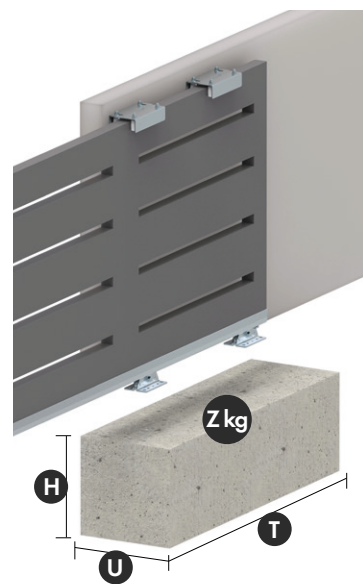

### NÁŠ ON-LINE KONFIGURÁTOR PRO SAMONOSNÉ BRÁNY

Naskenujte QR kód a zvolte si takovou řadu pro samonosné brány, která bude co nejlépe vyhovovat vašim požadavkům.

Přímo na našem webu je možné velmi snadno on-line vyhodnotit, které sady a příslušenství jsou nejvhodnější pro vaše potřeby.

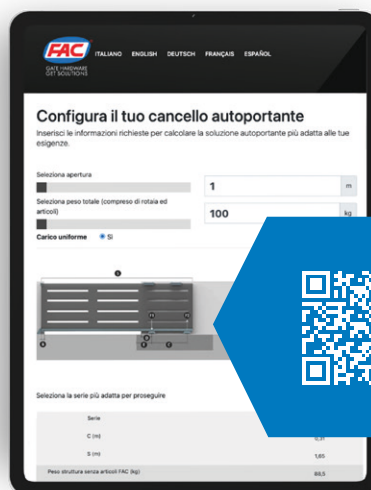

**NASKENUJTE QR KÓD!**

### NOVÉ ŘADY PRO SAMONOSNÉ BRÁNY

Podrobnější informace jsou uvedeny v příslušném technickém listu.

## TABULKA ROZMĚRŮ

ŘADA	A (m)	C (m)	S (m)	P max CUn (Kg)	Z min CUn (Kg)	P rám CUn (Kg)	T (m)	U (m)	H (m)	Konstantní hodnoty
ŘADA 800	2	0,8	3,1	270	560	85	1,3	0,4	0,8	F1 max [KG]:500 D [m]: 0,12 B [m]: 0,07 G min [m]: 0,05 E min [m]: 0,25 A/C: 2,5
	2,5	1	3,8	270	560	70	1,5	0,4	0,8	
	3	1,2	4,5	270	560	60	1,7	0,4	0,8	
	3,5	1,4	5,2	270	560	50	1,9	0,4	0,8	
	4	1,6	5,9	270	560	45	2,1	0,4	0,8	
ŘADA 900	3	1,2	4,7	420	900	85	1,8	0,5	0,8	F1 max [KG]:800 D [m]: 0,20 B [m]: 0,13 G min [m]: 0,06 E min [m]: 0,30 A/C: 2,5
	3,5	1,4	5,4	420	900	74	2	0,5	0,8	
	4	1,6	6,1	420	900	65	2,2	0,5	0,8	
	5	2	7,5	420	900	50	2,6	0,5	0,8	
ŘADA 1000	5	2	7,6	600	1500	95	2,7	0,6	1,0	F1 max [KG]:1350 D [m]: 0,26 B [m]: 0,15 G min [m]: 0,08 E min [m]: 0,35 A/C: 2,5
	6	2,4	9	600	1500	80	3,1	0,6	1,0	
ŘADA 2000	6	2,4	9,1	850	2300	115	3,3	0,8	1,0	F1 max [KG]: 2000 D [m]: 0,29 B [m]: 0,15 G min [m]: 0,08 E min [m]: 0,45 A/C: 2,5
	7	2,8	10,5	850	2300	95	3,7	0,8	1,0	
	8	3,2	11,9	850	2300	85	4,1	0,8	1,0	
	10	4	14,7	850	2300	65	4,9	0,8	1,0	
ŘADA 2500 <b>NOVÉ</b>	6	2,4	9,1	1000	2300	118	3,3	0,8	1,0	F1 max [KG]:2000 D [m]: 0,26 B [m]: 0,15 G min [m]: 0,8 E min [m]: 0,45 A/C: 2,5
	7	2,8	10,5	1000	2300	100	3,7	0,8	1,0	
	8	3,2	11,9	1000	2300	87	4,1	0,8	1,0	
	10	4	14,7	1000	2300	67	4,9	0,8	1,0	
ŘADA 3000	10	4	15	1500	3700	90	5,2	1	1,0	F1 max [KG]:3200 D [m]: 0,46 B [m]: 0,18 G min [m]: 0,10 E min [m]: 0,60 A/C: 2,5
	12	4,8	17,8	1500	3700	72	6	1	1,0	
	14	5,6	20,6	1500	3700	58	6,8	1	1,0	
ŘADA 2000H	8	2,975	12	1600	5000	175	4,2	1	1,2	F1 max [KG]:4000 D [m]: 0,435 B [m]: 0,155 G min [m]: 0,12 E min [m]: 0,6 S=1,5 x A
	10	3,975	15	1600	5000	137	5,2	1	1,2	
	12	4,975	18	1600	5000	114	6,2	1	1,2	
	14	5,975	21	1600	5000	96	7,2	1	1,2	
	16	6,975	24	1600	5000	84	8,2	1	1,2	
ŘADA 3500 <b>NOVÉ</b>	16	6,4	23,4	2000	4600	69	7,6	1	1,2	F1 max [KG]:4200 D [m]: 0,40 B [m]: 0,18 G min [m]: 0,10 E min [m]: 0,60 A/C: 2,5
ŘADA 4000 <b>NOVÉ</b>	20 m / 3500 kg pro podrobnější informace nás kontaktujte									



# SAMONOSNÉ BRÁNY

**HLEDÁTE ŘEŠENÍ PRO SVŮJ PROJEKT?**

**KONTAKTUJTE NÁS!**

Výhradní distributor pro ČR:

Janů a syn s.r.o.

Pražská 144/32, 418 01 Bílina

Tel. +420 417 823 106

[info@komponentyfac.cz](mailto:info@komponentyfac.cz) • [info@januasyn.cz](mailto:info@januasyn.cz)

Adresa provozovny: Bílinská 351, 418 01 Bílina

[www.komponentyfac.cz](http://www.komponentyfac.cz)

[www.januasyn.cz](http://www.januasyn.cz)

